

xclick s recessed/surface

5 YEARS
WARRANTY



RECESSED, SURFACE AND SUSPENDED MOUNTING

EN

System of recessed and surface profiles, with internal circuits at 48V DC, used to assemble continuous structures.

The profiles are in extruded aluminum, electrostatically painted (liquid) in black, with 15mm useful width.

The recessed profiles are installed in plasterboard dropped ceiling or walls, trimless. Mechanical connections at 90° in the same or different planes are possible for both versions, recessed or surface.

Mechanical connectors must be used together with SCKRS01FC accessory for joining electrical terminations.

This lighting system can be fitted with linear light fittings, fixed or adjustable, equipped with SMD or power LEDs, with adjustable mini projectors and decorative luminaires, as well as with other accessories for installation and electrical connection.

The light fittings from this system are mounted mechanically on the entire length of the profile by means of two self-returning buttons.

Range of applications

General or local lighting in offices, reception areas, conference rooms or public working spaces.

Individual mounting or in continuous light structures.

RO

Sistem de profile încastate și aparente, cu circuite interne la 48V DC, pentru realizarea de structuri continue.

Profilele sunt fabricate din aluminiu extrudat, vopsite negru în câmp electrostatic (lichid) și au lățimea utilă de 15 mm.

Cele încastate se instalează în tavane sau pereți de gipscarton, fără margini de încastare vizibile.

Sunt disponibile pentru ambele versiuni, încastată sau aparentă, elemente pentru conexiunile mecanice la 90°, în același plan sau în plane diferite.

Aceste elemente de conectare trebuie folosite împreună cu accesoriul SCKRS01FC pentru realizarea conexiunilor electrice.

Acest sistem de iluminat este posibil să fie utilizat împreună cu corpuri de iluminat liniare fixe sau orientabile, echipate cu LED-uri SMD sau de putere, mini proiectoare orientabile și corpuri de iluminat decorative, precum și cu alte accesorii de instalare și de realizare a conexiunilor.

Corpurile de iluminat ale acestui sistem se instalează mecanic, pe toată lungimea profilului, prin intermediul a două butoane laterale cu revenire.

Aplicații

Iluminatul general sau local în birouri, zone de recepție, săli de conferințe sau spații de lucru cu publicul.

Montaj individual sau în structuri luminoase continue.

IT

Sistema di profili da incasso o da superficie, equipaggiati con circuiti interni a 48V DC, per la creazione di strutture continue.

I profili sono in alluminio estruso, verniciati nero in campo elettrostatico liquido con larghezza utile di 15 mm.

Quelli da incasso si installano in controsoffitti o pareti in cartongesso, a filo senza rivestimento del bordo del profilo (trimless).

Sono disponibili per entrambe le versioni ad incasso o da superficie, elementi per connessioni meccaniche a 90°, sullo stesso piano o su piani diversi.

Questi elementi di collegamento devono essere utilizzati insieme all'accessorio SCKRS01FC per effettuare i collegamenti elettrici.

Questo sistema di illuminazione può essere utilizzato in combinazione con apparecchi lineari fissi o regolabili, equipaggiati con LED SMD o di potenza, mini proiettori orientabili e apparecchi decorativi e con altri accessori per installazione e connessione.

Gli apparecchi di questo sistema sono installati meccanicamente lungo il profilo, mediante due tasti di ritorno laterali.

Campi di applicazione

Iluminazione generale o locale di uffici, zone di ricezione, sale conferenza o spazi pubblici.

Installazione singola o in strutture luminose continue.



XCLICK S OVERVIEW

TRACK RECESSED OR SURFACE MODELS

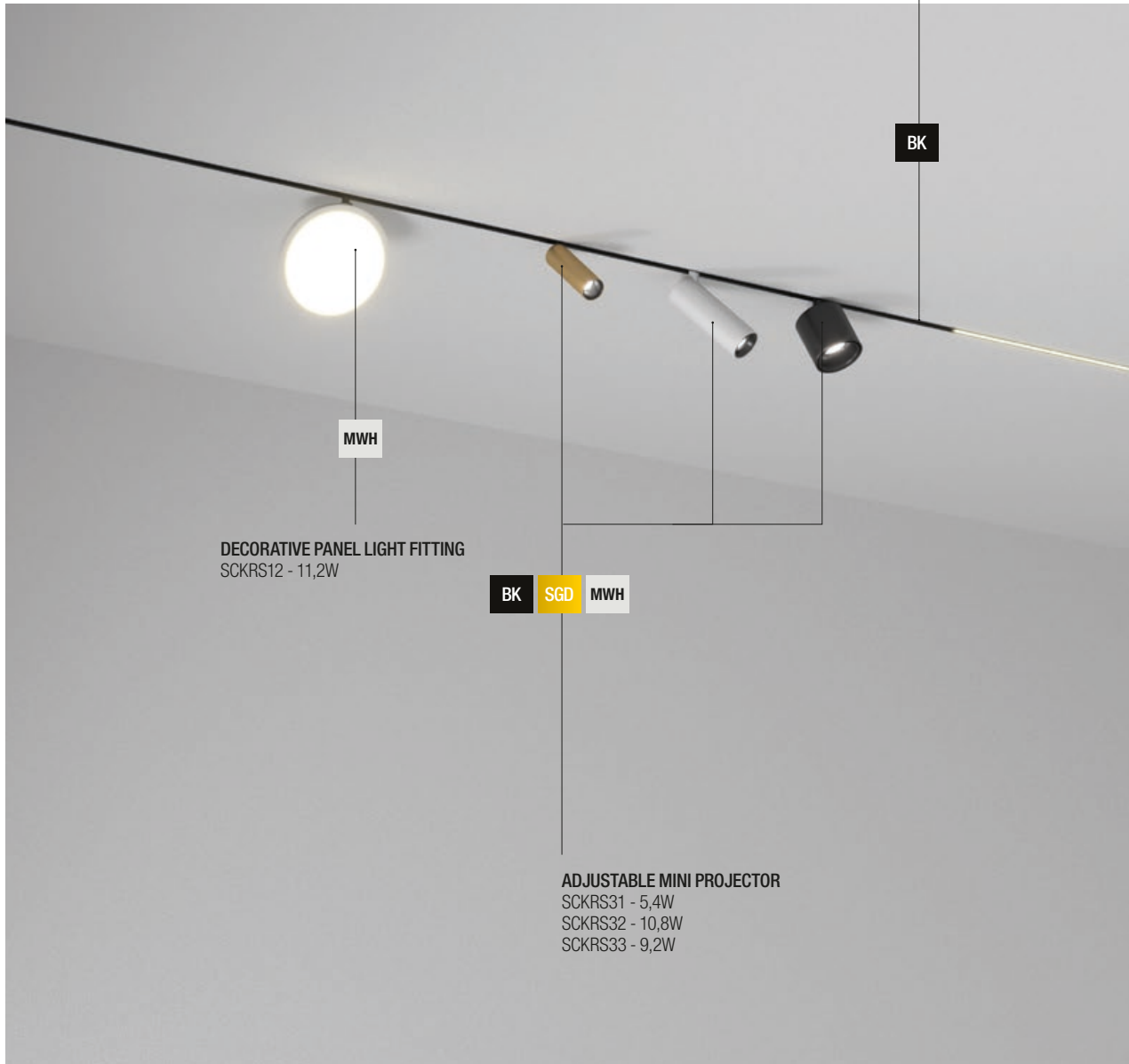

RECESSED MOUNTING



SURFACE MOUNTING

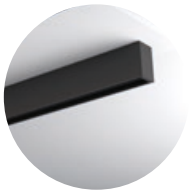

SUSPENDED MOUNTING



⚠ WARNING!

These profiles can be cut at the desired dimension (200 mm minimum for the installing of the connecting element).

Changing the position of a luminaire in a profile is made by removing it from its original position and reassembling it in the new position.

It is forbidden to move the body along the profile without dismantling as to avoid damaging of the flexible power contacts.

Maximum allowed power for a single power supply is 350W.

The allowed maximum length for a continuous system with a single power supply is 5m.

Aceste profile pot fi tăiate la dimensiunea dorită (minim 200 mm pentru montajul elementului de conexiune).

Schimbarea poziției într-un profil se face prin demontarea și remontarea corpului în noua poziție. Este interzisă glisarea corpului în lungul profilului fără demontare pentru a evita deteriorarea contactelor flexibile de alimentare.

Puterea maximă admisă pentru o singură alimentare este de 350W.

Lungimea maximă admisă pentru un sistem cu o singură alimentare este de 5m.

Questi profili possono essere tagliati alla dimensione desiderata (minimo 200 mm per il montaggio dell'elemento di collegamento).

È necessario disinstallare l'apparecchio dal profilo per cambiare la sua posizione all'interno del profilo, non muovere l'apparecchio a destra o a sinistra, questa operazione potrebbe danneggiare i contatti flessibili d'alimentazione.

La potenza massima consentita per una singola alimentazione è di 350W.

Lunghezza massima consentita per un sistema con una singola alimentazione è di 5m.

DECORATIVE SPHERICAL LIGHT FITTING
SCKRS11 - 6W

ADJUSTABLE LINEAR SPOTLIGHT
SCKRS21 - 4,5W
SCKRS22 - 9W



BK

FINISHING AVAILABLE

BK SGD MWH

BK

FINISHING AVAILABLE

BK SGD MWH

BK

DECORATIVE SUSPENDED LIGHT FITTINGS
SCKRS14 - 5,2W
SCKRS15 - 4,6W

FINISHING AVAILABLE

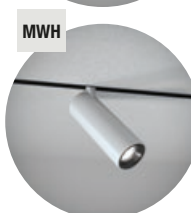

BK

SGD

MWH

RECOMMENDED CV DRIVERS
AT48 SERIE

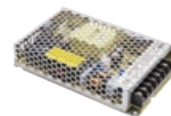

LINEAR LIGHT FITTINGS

- SCKRS01 - 11,4W L. 306 mm
- SCKRS02 - 20W L. 606 mm
- SCKRS03 - 30W L. 906 mm
- SCKRS04 - 40W L. 1196 mm
- SCKRS05 - 50W L. 1496 mm

xclick s recessed/surface



RECESSED MOUNTING

RECESSED PROFILE

FINISHING AVAILABLE

BK

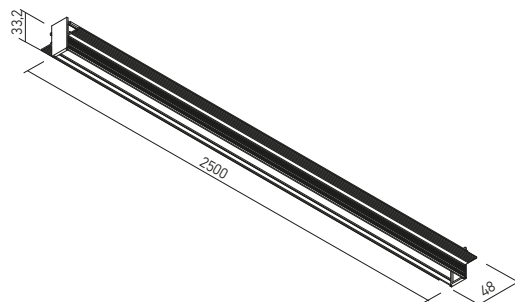
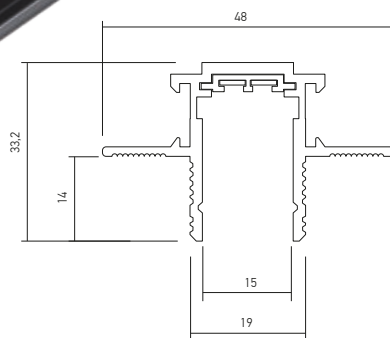

Code	Finishing	Input voltage	Length	Weight
SCKR01	BK	48V DC	2500 mm	1,43 kg

Extruded aluminum profile electrostatically painted (liquid) in black. End caps of black ABS.

Profil din aluminiu extrudat vopsit electrostatic (lichid), culoare neagră. Elemente terminale din ABS de culoare neagră.

Profilo estruso di alluminio verniciato elettrostatico (liquido), colore nero. Elementi terminali in ABS nero.

RECESSED EXTERNAL ANGLE CONNECTOR

FINISHING AVAILABLE

BK

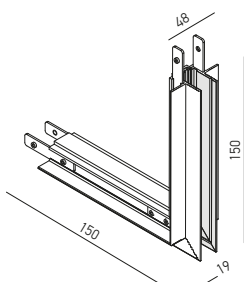

Code	Finishing	Weight
SCKR01EAC	BK	0,18 kg

Structural element with recessed mounting, for the mechanical connection of two linear profiles at 90°, in different mounting planes (external angle), equipped with electrical circuit for 48V DC.

It is mounted in plasterboard dropped ceilings or walls, trimless installing.

For the electrical connections the structural element is used together with a flexible electrical connector SCKRS01FC. *Element de structură cu montaj încastrat, pentru conexiunea mecanică a două profile liniare la 90°, în plane de montaj diferite (unghi extern), echipat cu circuit pentru 48V DC.*

Se montează în tavane sau pereți din gipscarton, cu profilul fără ramă vizibilă.

Pentru realizarea conexiunilor electrice elementul de structură se utilizează împreună cu un conector electric flexibil SCKRS01FC.

Elemento angolare (angolo esterno) della struttura da incasso per il collegamento meccanico di due profili lineari su diversi piani di montaggio a 90°, dotato di un circuito da 48V DC.

Si installa su controsoffitti o pareti in cartongesso, a filo, senza rivestimento del bordo del profilo.

Per i collegamenti elettrici l'elemento strutturale viene utilizzato insieme con un connettore elettrico flessibile SCKRS01FC.

RECESSED INTERNAL ANGLE CONNECTOR

FINISHING AVAIL

BK

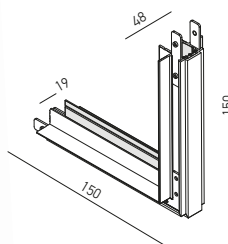

Code	Finishing	Weight
SCKR01IAC	BK	0,19 kg

Structural element with recessed mounting, for the mechanical connection of two linear profiles at 90°, in different mounting planes (internal angle), equipped with electrical circuit for 48V DC. It is mounted in plasterboard dropped ceilings or walls, trimless installing.

For the electrical connections the structural element is used together with a flexible electrical connector SCKRS01FC. *Element de structură cu montaj încastrat, pentru conexiunea mecanică a două profile liniare la 90°, în plane de montaj diferite (unghi intern), echipat cu circuit pentru 48V DC.*

Se montează în tavane sau pereți din gipscarton, cu profilul fără ramă vizibilă.

Pentru realizarea conexiunilor electrice elementul de structură se utilizează împreună cu un conector electric flexibil SCKRS01FC.

Elemento angolare (angolo interno) della struttura da incasso per il collegamento meccanico di due profili lineari su diversi piani di montaggio a 90°, dotato di un circuito da 48V DC.

Si installa su controsoffitti o pareti in cartongesso, a filo, senza rivestimento del bordo del profilo.

Per i collegamenti elettrici l'elemento strutturale viene utilizzato insieme con un connettore elettrico flessibile SCKRS01FC.

RECESSED 90° ANGLE

FINISHING AVAILABLE

BK

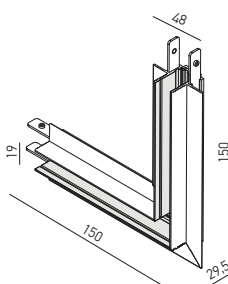

Code	Finishing	Weight
SCKR01C90	BK	0,18 kg

Structural element with recessed mounting, for the mechanical connection of two linear profiles at 90°, in the same mounting plane, equipped with electrical circuit for 48V DC. It is mounted in plasterboard dropped ceilings or walls, trimless installing.

For the electrical connections the structural element is used together with a flexible electrical connector SCKRS01FC. *Element de structură cu montaj încastrat, pentru conexiunea mecanică a două profile liniare la 90°, în același plan de montaj, echipat cu circuit pentru 48V DC.*

Se montează în tavane sau pereți din gipscarton, cu profilul fără ramă vizibilă.

Pentru realizarea conexiunilor electrice elementul de structură se utilizează împreună cu un conector electric flexibil SCKRS01FC.

Elemento angolare della struttura da incasso per il collegamento meccanico di due profili lineari nello stesso piano di montaggio a 90°, dotato di un circuito da 48V DC.

Si installa su controsoffitti o pareti in cartongesso, a filo, senza rivestimento del bordo del profilo.

Per i collegamenti elettrici l'elemento strutturale viene utilizzato insieme con un connettore elettrico flessibile SCKRS01FC.

xclick s recessed/surface



- CE
- LED
- House icon
- III
- IP20
- Light fixture icon
- Light fixture icon
- Light fixture icon

SURFACE MOUNTING

SURFACE PROFILE

FINISHING AVAILABLE

BK

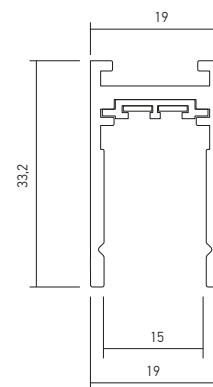
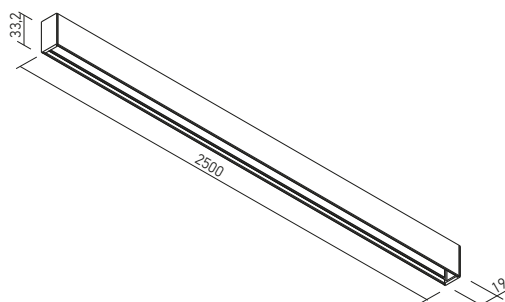
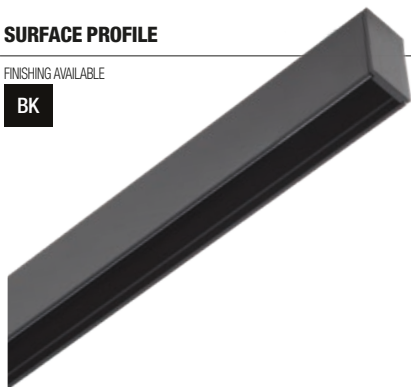

Code	Finishing	Input voltage	Length	Weight
SCKS01	BK	48V DC	2500 mm	1,28 kg

Extruded aluminum profile electrostatically painted (liquid) in black. End caps of black ABS.

Profil din aluminiu extrudat vopsit electrostatic (lichid), culoare neagră.

Elemente terminale din ABS de culoare neagră.

Profilo estruso di alluminio verniciato elettrostatico (liquido), colore nero.

Elementi terminali in ABS nero.

MECHANICAL POWER SUPPLY

FINISHING AVAILABLE

BK

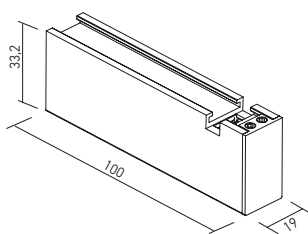

Structural element for surface mounting, 10 cm length, equipped with circuit for 48V DC.

It is provided with two side cutouts for the access of the power supply cable.

It comes with two terminal elements, one with a cable entry hole, and one without (if the access of the cable is sideways).

Element de structură pentru montaj aparent, cu lungimea de 10 cm, echipat cu circuit pentru 48V DC.

Este prevăzut cu două decupări laterale pentru accesul cablului de alimentare.

Se livrează cu două elemente terminale, unul cu gaură pentru accesul cablului de alimentare prin capăt și unul fără în situația accesului cablului prin lateral.

Elemento della struttura da superficie, lunghezza 10 cm, equipaggiato con circuito da 48V DC.

È dotato di due aperture laterali per l'accesso al cavo di alimentazione.

Viene fornito con due elementi terminali, uno con un foro di ingresso del cavo e uno senza foro (se l'accesso del cavo è laterale).

Code	Finishing	Weight
SCKS01SCT	BK	0,06 kg

SURFACE INTERNAL ANGLE CONNECTOR

FINISHING AVAILABLE

BK

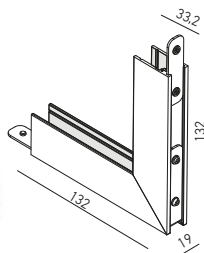

Structural element (internal angle) with surface mounting, for the mechanical connection of two linear profiles at 90°, equipped with electrical circuit for 48V DC.

For the electrical connections the structural element is used together with a flexible electrical connector SCKRS01FC.

Element de structură (unghi intern) cu montaj aparent, pentru conexiunea mecanică a două profile liniare la 90°, echipat cu circuit pentru 48V DC.

Pentru realizarea conexiunilor electrice elementul de structură se utilizează împreună cu un conector electric flexibil SCKRS01FC.

Elemento angolare (angolo interno) della struttura da parete/soffitto per il collegamento meccanico di due profili lineari a 90°, dotato di un circuito da 48V DC.

Per i collegamenti elettrici l'elemento strutturale viene utilizzato insieme a un connettore elettrico flessibile SCKRS01FC.

Code	Finishing	Weight
SCKS01IAC	BK	0,15 kg

SURFACE 90° ANGLE

FINISHING AVAILABLE

BK

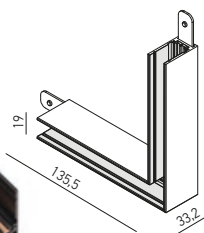

Structural element with surface mounting, for the mechanical connection of two linear profiles at 90°, in the same mounting plane, equipped with electrical circuit for 48V DC.

For the electrical connections the structural element is used together with a flexible electrical connector SCKRS01FC.

Element de structură cu montaj aparent, pentru conexiunea mecanică a două profile liniare la 90°, în același plan de montaj, echipat cu circuit pentru 48V DC.

Pentru realizarea conexiunilor electrice elementul de structură se utilizează împreună cu un conector electric flexibil SCKRS01FC.

Elemento angolare della struttura da parete/soffitto per il collegamento meccanico di due profili lineari nello stesso piano di montaggio a 90°, dotato di un circuito da 48V DC.

Per i collegamenti elettrici l'elemento strutturale viene utilizzato insieme a un connettore elettrico flessibile SCKRS01FC.

Code	Finishing	Weight
SCKS01C90	BK	0,15 kg

SUSPENDED MOUNTING





PROFILE ELEMENT SUSPENSION



CEILING ELEMENT SUSPENSION



xclick s recessed/surface

MOUNTING ACCESSORIES



ELECTRICAL POWER SUPPLY CONNECTOR

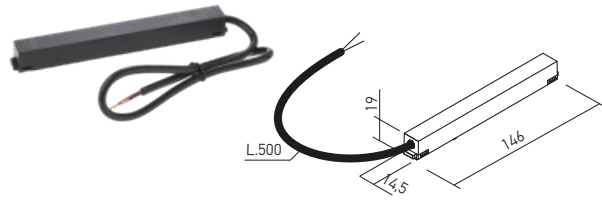

Code	Finishing	Input voltage	Weight
SCKRS01PC0.5	BK	48V DC	0,05 kg

Power supply element for the profiles of the recessed or surface structures for connection to the 48V DC driver.

Element de alimentare pentru profilele structurilor încastrate sau aparente care asigură legătura cu alimentatorul de 48V DC.

Elemento di alimentazione per profili delle strutture da incasso e parete/soffitto, per il collegamento all'alimentatore da 48V DC.

ELECTRICAL POWER SUPPLY CONNECTOR FOR SUSPENSION

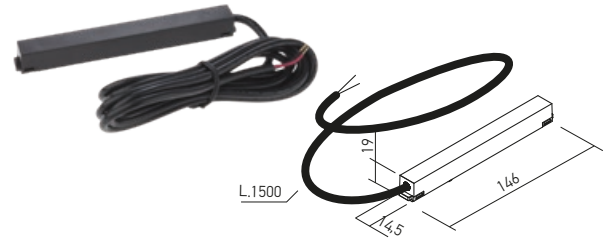

Code	Finishing	Input voltage	Weight
SCKS01PC1.7	BK	48V DC	0,07 kg

Power supply element for the profiles of the surface structures, suspended installing, for connection to the 48V DC driver.

Element de alimentare pentru profilele structurilor aparente, montaj suspendat, care asigură legătura cu alimentatorul de 48V DC.

Elemento di alimentazione per profili delle strutture da superficie, montaggio a sospensione, per il collegamento all'alimentatore da 48V DC.

FLEXIBLE ELECTRICAL CONNECTOR

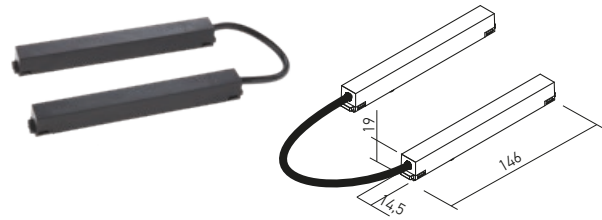

Code	Finishing	Input voltage	Weight
SCKRS01FC	BK	48V DC	0,06 kg

Element for angular electrical connection between two profiles of the recessed or surface structures.

Element pentru conexiunea electrică unghiulară între două profile ale structurilor încastrate sau aparente.

Elemento per la connessione elettrica angolare tra due profili delle strutture da incasso o da parete/soffitto.

ELECTRICAL LINEAR CONNECTOR

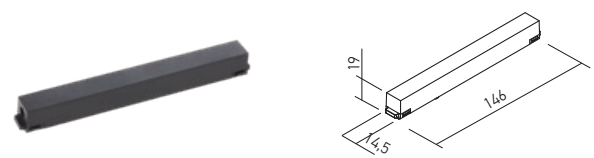

Code	Finishing	Input voltage	Weight
SCKRS01LC	BK	48V DC	0,03 kg

Element for linear electrical connection between two profiles of the recessed or surface structures.

Element pentru conexiunea electrică liniară între două profile ale structurilor încastrate sau aparente.

Elemento per la connessione elettrica lineare tra due profili delle strutture da incasso o da parete/soffitto.

FRONT COVER

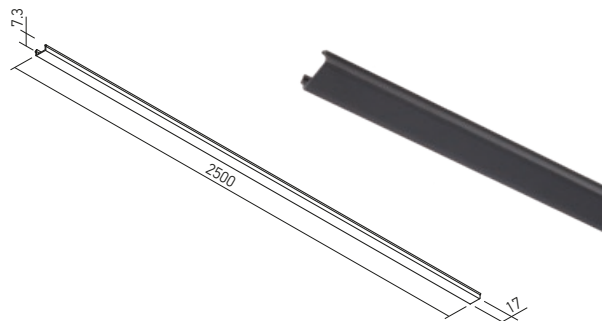

Code	Finishing	Length	Weight
SCKRS01CV	BK	2500 mm	0,16 kg

Front cover for masking the remaining open areas in the recessed or surface profiles after installing the light fittings.

Accesoriu frontal pentru mascarea zonelor libere rămase în profilele încastrate sau aparente după montajul corpurilor de iluminat.

Copertura frontale per mascherare gli spazi liberi nei profili da incasso o di superficie dopo l'installazione degli apparecchi.

CEILING FIXING ELEMENT

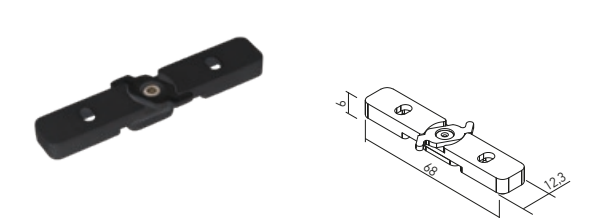

Code	Finishing
SCKS01CF	BK

Element for connection on the wall or on the ceiling for the linear profiles of the family XCLICK S SURFACE.

Element pentru fixarea pe perete sau tavan a profilelor liniare din familia XCLICK S SURFACE.

Elemento per fissaggio a parete o soffitto di profili lineari della famiglia XCLICK S SURFACE.

END CAP

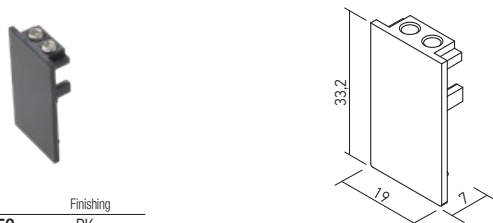

Code	Finishing
SCKRS01EC	BK

End cap for the recessed or surface profiles of XCLICK S system.
Element terminal pentru profilele încastrate și aparente ale sistemului XCLICK S.
 Tappo di chiusura per profili di sistema XCLICK S da incasso o di superficie.

END CAP WITH HOLE

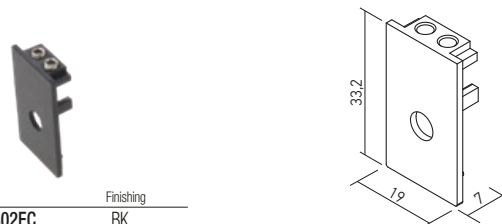

Code	Finishing
SCKRS02EC	BK

End cap for the recessed or surface profiles of the XCLICK S system.
 Provided with central access hole for power supply cable.
Element terminal pentru profilele încastrate și aparente ale sistemului XCLICK S.
Prevăzut cu gaură centrală de acces pentru cablul de alimentare.
 Tappo di chiusura per profili del sistema XCLICK S da incasso o da superficie.
 Fornito con foro centrale di accesso per cavo di alimentazione.

PROFILE ELEMENT SUSPENSION



Code	Finishing
SCKS01MSU	BK

Suspension element for the XCLICK S SURFACE profile (cable of twisted steel wires, 1,5m maximum length and steel fittings for fixing on the light fitting).
Element de suspendare pentru profilul XCLICK S SURFACE (cablu torsadat din fire de oțel, lungimea maximă 1,5m și accesoriu de fixare din oțel pentru corpul de iluminat).
 Elemento di sospensione per profilo XCLICK S SURFACE (filo di acciaio intrecciato, con lunghezza massima da 1,5m e accessorio di fissaggio in acciaio per apparecchio).

CEILING ELEMENT SUSPENSION



Code	Finishing
SMCKS01CSU	BK

Element for ceiling fixing suspension of XCLICK S SURFACE and XCLICK M SURFACE profiles.
Element pentru fixarea pe tavan a suspensiei profilelor XCLICK S SURFACE și XCLICK M SURFACE.
 Elemento di fissaggio per la sospensione di profili XCLICK S SURFACE e XCLICK M SURFACE.

SURFACE DRIVER BOXES

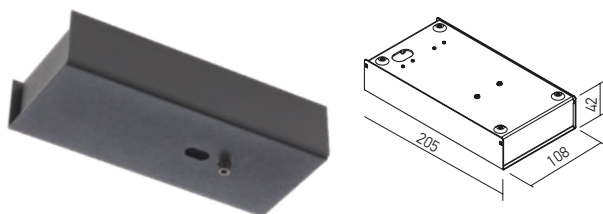

Code	Finishing	Weight
SMCKS01SDB	BK	0,76 kg

Box for installing of the drivers for the systems of XCLICK S SURFACE and XCLICK M SURFACE profiles with maximum powers of 100W.
 Housing of aluminum board, electrostatically painted in mat black, surface mounting.
Cutie pentru instalarea alimentatoarelor sistemelor de profile XCLICK S SURFACE și XCLICK M SURFACE, cu puteri de până la 100W.
Carcasă din tablă de aluminiu, vopsită în câmp electrostatic, culoare negru mat, cu montaj aparent.
 Scatola per l'installazione degli alimentatori dei sistemi XCLICK S SURFACE e XCLICK M SURFACE fino alla potenza di 100W.
 Corpo in lamiera di alluminio, verniciato a polveri nero opaco. Installazione da superficie.

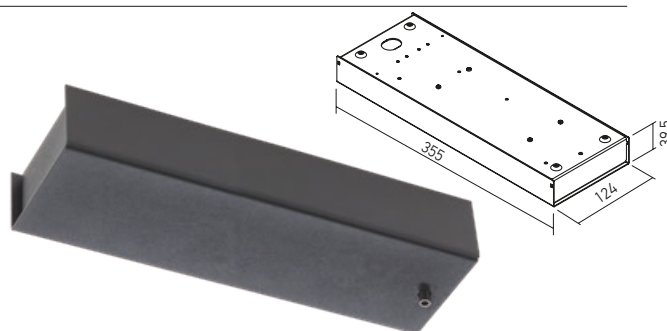

Code	Finishing	Weight
SMCKS02SDB	BK	1,32 kg

Box for installing of the drivers for the systems of XCLICK S SURFACE and XCLICK M SURFACE profiles with maximum powers of 200W.
 Housing of aluminum board, electrostatically painted in mat black, surface mounting.
Cutie pentru instalarea alimentatoarelor sistemelor de profile XCLICK S SURFACE și XCLICK M SURFACE, cu puteri de până la 200W.
Carcasă din tablă de aluminiu, vopsită în câmp electrostatic, culoare negru mat, cu montaj aparent.
 Scatola per l'installazione degli alimentatori dei sistemi XCLICK S SURFACE e XCLICK M SURFACE fino alla potenza di 200W.
 Corpo in lamiera di alluminio, verniciato a polveri nero opaco. Installazione da superficie.

TRIMLESS BOX FOR ELECTRICAL CONNECTION AND DRIVER ACCESS

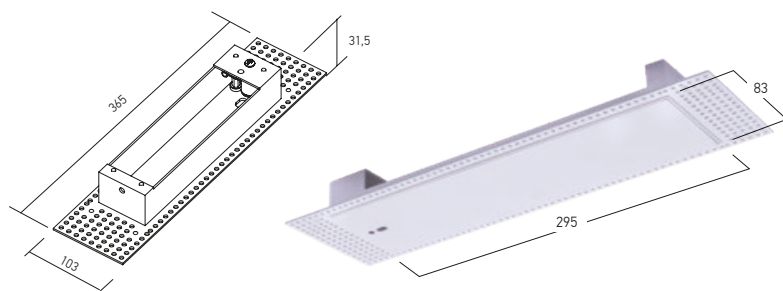

Code	Finishing	Weight
SMCKS02TDB	SWH	0,50 kg

Box for access of the drivers for the systems of XCLICK S RECESSED/SURFACE and XCLICK M RECESSED/SURFACE profiles in the false ceiling and making electrical connections.
Cutie pentru accesul alimentatoarelor sistemelor de profile XCLICK S RECESSED/SURFACE și XCLICK M RECESSED/SURFACE în tavanul fals și realizarea conexiunilor electrice.
 Scatola per accedere agli alimentatori e la realizzazione dei collegamenti elettrici nel controsoffitto per i sistemi di profili XCLICK S RECESSED/SURFACE e XCLICK M RECESSED/SURFACE.

xclick s recessed/surface



LIGHT FITTINGS

LINEAR LIGHT FITTINGS

FINISHING AVAILABLE

BK

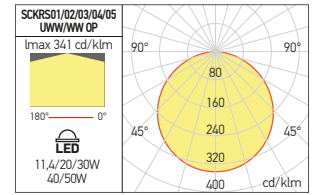
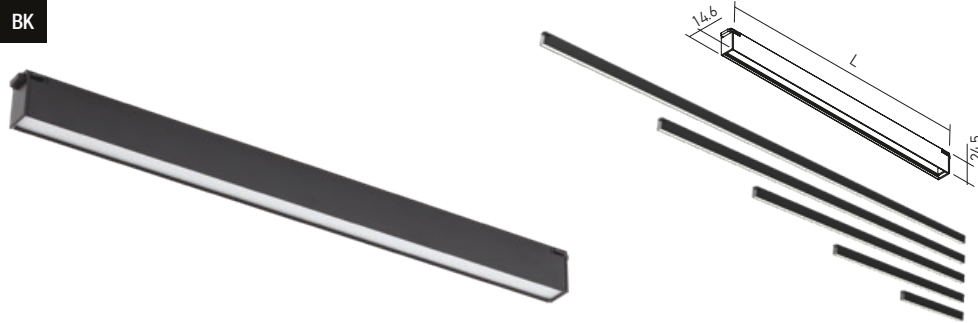

Code	Finishing	LED type	Power	Input voltage	LED flux	System flux	CCT	CRI	Optics	Length (L)	Weight
SCKRS01UWW OP	BK	SMD 2835 HONGLI	11,4W	48V DC	830 lm	441 lm	2700K	80	Large	306 mm	0,12 kg
SCKRS01WW OP	BK	SMD 2835 HONGLI	11,4W	48V DC	860 lm	456 lm	3000K	80	Large	306 mm	0,12 kg
SCKRS02UWW OP	BK	SMD 2835 HONGLI	20W	48V DC	1660 lm	882 lm	2700K	80	Large	606 mm	0,23 kg
SCKRS02WW OP	BK	SMD 2835 HONGLI	20W	48V DC	1720 lm	912 lm	3000K	80	Large	606 mm	0,23 kg
SCKRS03UWW OP	BK	SMD 2835 HONGLI	30W	48V DC	2490 lm	1323 lm	2700K	80	Large	906 mm	0,33 kg
SCKRS03WW OP	BK	SMD 2835 HONGLI	30W	48V DC	2590 lm	1368 lm	3000K	80	Large	906 mm	0,33 kg
SCKRS04UWW OP	BK	SMD 2835 HONGLI	40W	48V DC	3320 lm	1764 lm	2700K	80	Large	1196 mm	0,44 kg
SCKRS04WW OP	BK	SMD 2835 HONGLI	40W	48V DC	3460 lm	1824 lm	3000K	80	Large	1196 mm	0,44 kg
SCKRS05UWW OP	BK	SMD 2835 HONGLI	50W	48V DC	4150 lm	2205 lm	2700K	80	Large	1496 mm	0,55 kg
SCKRS05WW OP	BK	SMD 2835 HONGLI	50W	48V DC	4320 lm	2280 lm	3000K	80	Large	1496 mm	0,55 kg

Linear light fittings, for installation in the profiles of XCLICK S RECESSED and XCLICK S SURFACE systems, equipped with SMD LED module, opal diffuser and mechanical fastening system. Corpuri de iluminat liniare, pentru montajul în profilele sistemelor XCLICK S RECESSED și XCLICK S SURFACE, echipate cu modul cu LED-uri SMD, dispersor opal și sistem mecanic de fixare. Apparecchi lineari per installazione nei profili dei sistemi XCLICK S RECESSED e XCLICK S SURFACE, dotati di modulo a LED SMD, diffusore opalino e sistema meccanico di fissaggio.

ADJUSTABLE LINEAR SPOTLIGHTS

FINISHING AVAILABLE

BK **SGD** **MWH**

SCKRS21

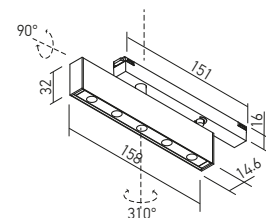
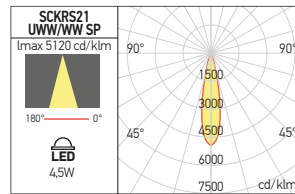

SCKRS22

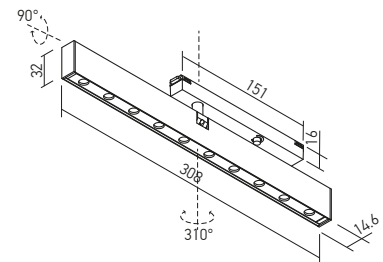
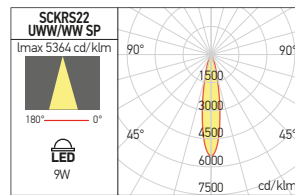

Code	Finishing	LED type	Power	Input voltage	LED flux	System flux	CCT	CRI	Optics	Weight
SCKRS21UWW SP BK	BK	POWER LED OSRAM	4,5W	48V DC	560 lm	197 lm	2700K	90	20°	0,18 kg
SCKRS21WW SP BK	BK	POWER LED OSRAM	4,5W	48V DC	580 lm	204 lm	3000K	90	20°	0,18 kg
SCKRS21UWW SP SGD	SGD	POWER LED OSRAM	4,5W	48V DC	560 lm	197 lm	2700K	90	20°	0,18 kg
SCKRS21WW SP SGD	SGD	POWER LED OSRAM	4,5W	48V DC	580 lm	204 lm	3000K	90	20°	0,18 kg
SCKRS21UWW SP MWH	MWH	POWER LED OSRAM	4,5W	48V DC	560 lm	197 lm	2700K	90	20°	0,18 kg
SCKRS21WW SP MWH	MWH	POWER LED OSRAM	4,5W	48V DC	580 lm	204 lm	3000K	90	20°	0,18 kg
SCKRS22UWW SP BK	BK	POWER LED OSRAM	9W	48V DC	1120 lm	567 lm	2700K	90	20°	0,31 kg
SCKRS22WW SP BK	BK	POWER LED OSRAM	9W	48V DC	1160 lm	587 lm	3000K	90	20°	0,31 kg
SCKRS22UWW SP SGD	SGD	POWER LED OSRAM	9W	48V DC	1120 lm	567 lm	2700K	90	20°	0,31 kg
SCKRS22WW SP SGD	SGD	POWER LED OSRAM	9W	48V DC	1160 lm	587 lm	3000K	90	20°	0,31 kg
SCKRS22UWW SP MWH	MWH	POWER LED OSRAM	9W	48V DC	1120 lm	567 lm	2700K	90	20°	0,31 kg
SCKRS22WW SP MWH	MWH	POWER LED OSRAM	9W	48V DC	1160 lm	587 lm	3000K	90	20°	0,31 kg

Adjustable linear projectors for installation in the profiles of XCLICK S RECESSED and XCLICK S SURFACE systems, equipped with power LEDs, FRESNEL lenses in PMMA and mechanical fastening system. Optical system UGR<16.

Proiectoare liniare orientabile pentru montajul în profilele sistemelor XCLICK S RECESSED și XCLICK S SURFACE, echipate cu LED-uri de putere, lentile FRESNEL din PMMA și sistem mecanic de fixare. Sistem optic UGR<16.

Proiettori lineari orientabili per l'installazione nei profili dei sistemi XCLICK S RECESSED e XCLICK S SURFACE, dotati di LED di potenza, lenti FRESNEL in PMMA e sistema di fissaggio meccanico. Sistema ottico UGR<16.

ADJUSTABLE MINI PROJECTORS

Adjustable and dimmable (PWM) mini projectors for installation in the profiles of XCLICK S RECESSED and XCLICK S SURFACE systems, equipped with power LED, mechanical fastening system.
 Mini proiectoare orientabile și dimabile (PWM), pentru montajul în profilele sistemelor XCLICK S RECESSED și XCLICK S SURFACE, echipate cu LED de putere, sistem mecanic de fixare.
 Mini proiettori orientabili e dimmerabili (PWM), per l'installazione nei profili dei sistemi XCLICK S RECESSED e XCLICK S SURFACE, dotati di LED di potenza, sistema di fissaggio meccanico.

SCKRS31

FINISHING AVAILABLE

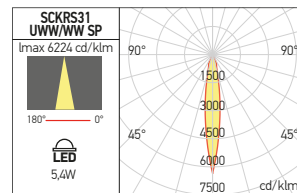
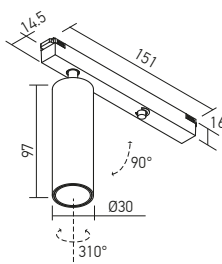

Code	Finishing	LED type	Power	Input voltage	LED flux	System flux	CCT	CRI	Optics	Weight
SCKRS31UWW SP BK	BK	POWER LED CREE	5,4W	48V DC	590 lm	393 lm	2700K	90	14°	0,19 kg
SCKRS31WW SP BK	BK	POWER LED CREE	5,4W	48V DC	690 lm	456 lm	3000K	90	14°	0,19 kg
SCKRS31UWW SP SGD	SGD	POWER LED CREE	5,4W	48V DC	590 lm	393 lm	2700K	90	14°	0,19 kg
SCKRS31WW SP SGD	SGD	POWER LED CREE	5,4W	48V DC	690 lm	456 lm	3000K	90	14°	0,19 kg
SCKRS31UWW SP MWH	MWH	POWER LED CREE	5,4W	48V DC	590 lm	393 lm	2700K	90	14°	0,19 kg
SCKRS31WW SP MWH	MWH	POWER LED CREE	5,4W	48V DC	690 lm	456 lm	3000K	90	14°	0,19 kg

SCKRS32

FINISHING AVAILABLE

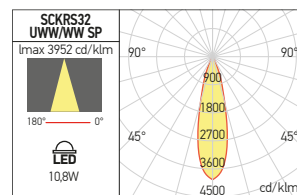
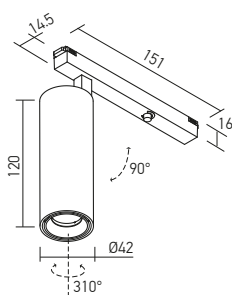

Code	Finishing	LED type	Power	Input voltage	LED flux	System flux	CCT	CRI	Optics	Weight
SCKRS32UWW SP BK	BK	COB LUMINUS	10,8W	48V DC	890 lm	592 lm	2700K	90	26°	0,31 kg
SCKRS32WW SP BK	BK	COB LUMINUS	10,8W	48V DC	1030 lm	684 lm	3000K	90	26°	0,31 kg
SCKRS32UWW SP SGD	SGD	COB LUMINUS	10,8W	48V DC	890 lm	592 lm	2700K	90	26°	0,31 kg
SCKRS32WW SP SGD	SGD	COB LUMINUS	10,8W	48V DC	1030 lm	684 lm	3000K	90	26°	0,31 kg
SCKRS32UWW SP MWH	MWH	COB LUMINUS	10,8W	48V DC	890 lm	592 lm	2700K	90	26°	0,31 kg
SCKRS32WW SP MWH	MWH	COB LUMINUS	10,8W	48V DC	1030 lm	684 lm	3000K	90	26°	0,31 kg

SCKRS33

FINISHING AVAILABLE

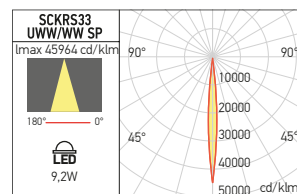
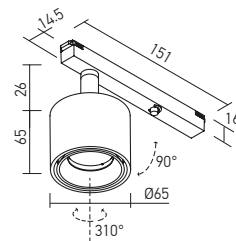

Code	Finishing	LED type	Power	Input voltage	LED flux	System flux	CCT	CRI	Optics	Weight
SCKRS33UWW SP BK	BK	COB LUMINUS	9,2W	48V DC	756 lm	466 lm	2700K	90	6°	0,29 kg
SCKRS33WW SP BK	BK	COB LUMINUS	9,2W	48V DC	809 lm	499 lm	3000K	90	6°	0,29 kg
SCKRS33UWW SP SGD	SGD	COB LUMINUS	9,2W	48V DC	756 lm	466 lm	2700K	90	6°	0,29 kg
SCKRS33WW SP SGD	SGD	COB LUMINUS	9,2W	48V DC	809 lm	499 lm	3000K	90	6°	0,29 kg
SCKRS33UWW SP MWH	MWH	COB LUMINUS	9,2W	48V DC	756 lm	466 lm	2700K	90	6°	0,29 kg
SCKRS33WW SP MWH	MWH	COB LUMINUS	9,2W	48V DC	809 lm	499 lm	3000K	90	6°	0,29 kg

xclick s recessed/surface



LIGHT FITTINGS

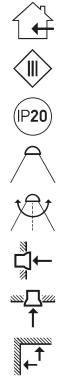

DECORATIVE SPHERICAL LIGHT FITTINGS

FINISHING AVAILABLE

BK

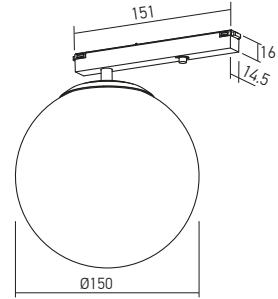
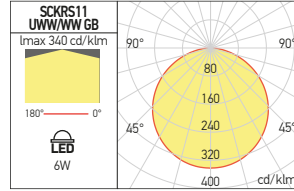

Code	Finishing	LED type	Power	Input voltage	LED flux	System flux	CCT	CRI	Optics	Weight
SCKRS11UWW GB	BK	COB LUMINUS	6W	48V DC	540 lm	363 lm	2700K	90	Large	0,44 kg
SCKRS11WW GB	BK	COB LUMINUS	6W	48V DC	630 lm	421 lm	3000K	90	Large	0,44 kg

Decorative light fitting with spherical shape, dimmable (PWM), for installation in the profiles of XCLICK S RECESSED and XCLICK S SURFACE systems, equipped with power LED and mechanical fastening system.

Corp de iluminat decorativ cu formă sferică, dimabil (PWM), pentru montajul în profilele sistemelor XCLICK S RECESSED și XCLICK S SURFACE, echipat cu LED de putere și sistem mecanic de fixare. Apparecchio decorativo sferico, dimmerabile (PWM), per l'installazione nei profili dei sistemi XCLICK S RECESSED e XCLICK S SURFACE, dotato di LED di potenza e sistema di fissaggio meccanico.

DECORATIVE PANEL LIGHT FITTINGS

FINISHING AVAILABLE

MWH

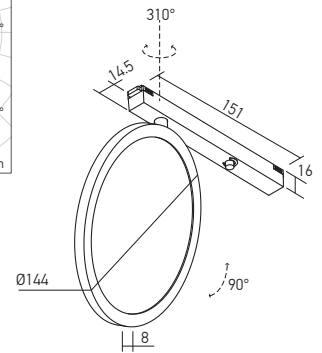
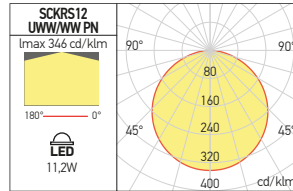

Code	Finishing	LED type	Power	Input voltage	LED flux	System flux	CCT	CRI	Optics	Weight
SCKRS12UWW PN	MWH	SMD 3014 EDISON	11,2W	48V DC	1150 lm	527 lm	2700K	90	Large	0,37 kg
SCKRS12WW PN	MWH	SMD 3014 EDISON	11,2W	48V DC	1320 lm	611 lm	3000K	90	Large	0,37 kg

Decorative light fitting, panel type, dimmable (PWM), for installation in the profiles of XCLICK S RECESSED and XCLICK S SURFACE systems, equipped with SMD LEDs and mechanical fastening system.

Corp de iluminat decorativ tip panou cu LED-uri, dimabil (PWM), pentru montajul în profilele sistemelor XCLICK S RECESSED și XCLICK S SURFACE, echipat cu LED SMD și sistem mecanic de fixare. Apparecchio decorativo tipo pannello a LED, dimmerabile (PWM), per l'installazione nei profili dei sistemi XCLICK S RECESSED e XCLICK S SURFACE, dotato di LED SMD e sistema di fissaggio meccanico.

DECORATIVE SUSPENDED LIGHT FITTINGS

SCKRS14

FINISHING AVAILABLE

BK SGD MWH

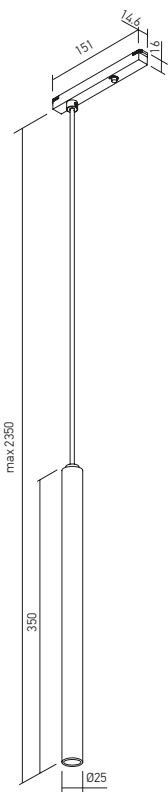
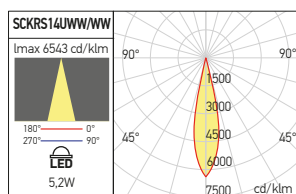

SCKRS15

FINISHING AVAILABLE

BK

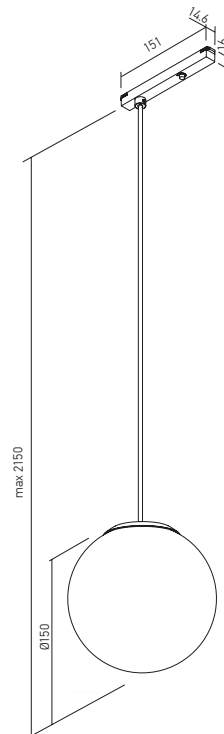
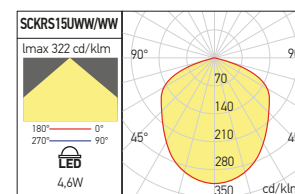
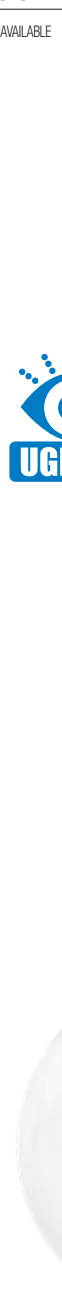

xclick s recessed/surface

Code	Finishing	LED type	Power	Input voltage	LED flux	System flux	CCT	CRI	Optics	Weight
SCKRS14UWW SU BK	BK	POWER LED CREE	5,2W	48V DC	600 lm	223 lm	2700K	90	19°	0,70 kg
SCKRS14WW SU BK	BK	POWER LED CREE	5,2W	48V DC	690 lm	255 lm	3000K	90	19°	0,70 kg
SCKRS14UWW SU SGD	SGD	POWER LED CREE	5,2W	48V DC	600 lm	223 lm	2700K	90	19°	0,70 kg
SCKRS14WW SU SGD	SGD	POWER LED CREE	5,2W	48V DC	690 lm	255 lm	3000K	90	19°	0,70 kg
SCKRS14UWW SU MWH	MWH	POWER LED CREE	5,2W	48V DC	600 lm	223 lm	2700K	90	19°	0,70 kg
SCKRS14WW SU MWH	MWH	POWER LED CREE	5,2W	48V DC	690 lm	255 lm	3000K	90	19°	0,70 kg
SCKRS15UWW SU	BK	COB LED	4,6W	48V DC	440 lm	302 lm	2700K	90	Large	0,40 kg
SCKRS15WW SU	BK	COB LED	4,6W	48V DC	510 lm	350 lm	3000K	90	Large	0,40 kg

Decorative suspensions, dimmable (PWM), for installation in the profiles of XCLICK S RECESSED and XCLICK S SURFACE systems, equipped with power or COB LEDs and mechanical fastening system.
 Suspensii decorative dimabile (PWM), pentru montajul în profilele sistemelor XCLICK S RECESSED și XCLICK S SURFACE, echipate cu LED-uri de putere sau COB și sistem mecanic de fixare.
 Sospensioni decorative dimmerabili (PWM), per installazione nei profili dei sistemi XCLICK S RECESSED e XCLICK S SURFACE, dotate di LED di potenza o COB, sistema di fissaggio meccanico.