

# Fili di luce tessono trame e atmosfere

Wires of light weave textures  
and atmospheres

Da quasi invisibile a rivelato, 35 crea dettagli nascosti o è il protagonista di un'installazione che lascia a bocca aperta. La sua sottigliezza traccia una linea minima tra dettagli funzionali, elementi grafici e aspetti decorativi utilizzando materiali, colori e luce.

From hidden to revealed, 35 can create concealed details or be the centerpiece of a breathtaking installation. Its subtleness draws a thin line between functional details, graphical statements and decorative features using materials, colors and light.



Grazie alla sua distribuzione a 360 gradi, alle luci spot miniaturizzate configurabili e a numerose finiture e opzioni cromatiche, da quasi invisibile a rivelato, Trentacinque (35) crea dettagli nascosti o diventa il protagonista dell'ambiente

With 360 degree distribution, configurable miniature spot lights and a multitude of colour finishes and options, from hidden to revealed, Trentacinque (35) creates concealed details or becomes the centerpiece of the project.



# Caratteristiche

## Features

Il sistema lineare sospeso Trentacinque (35) svolge tre diverse tipologie

di illuminazione: luce indiretta diffusa verso l'alto, luce diretta diffusa verso il basso, e luce d'accento.

**35 Linear** è un elemento cilindrico che crea luce diffusa verso l'alto e/o luce diffusa verso il basso.

**Nanoperfetto Trentacinque (35)** è un proiettore orientabile miniaturizzato per luce d'accento.

Usando questi elementi modulari, il sistema Trentacinque (35) è facilmente configurabile per progettare l'illuminazione di uno spazio con una totale flessibilità di forme e funzioni.

**35 Track** unisce la morbidezza della luce diffusa indiretta tipica del 35 alla massima flessibilità d'uso e performance del binario 48V<sub>DC</sub>, consentendo una maggiore possibilità di configurazione del sistema luminoso.

**35 suspended linear system** has three different types of light: indirect diffused uplight, direct diffused downlight, and accent lighting. **35 Linear** is a cylindrical element that can create diffused uplight and/or diffused downlight.

**Nanoperfetto 35** spotlight is a miniaturized adjustable spotlight for accent lighting.

Using these modular elements, the 35 system can be configured to shape the light as required, with flexibility in forms and functions. **35 Track** combines diffused uplight, with the maximum flexibility and the extensive performance of the 48V<sub>DC</sub> track, allowing for greater possibility of configuring the lighting system.

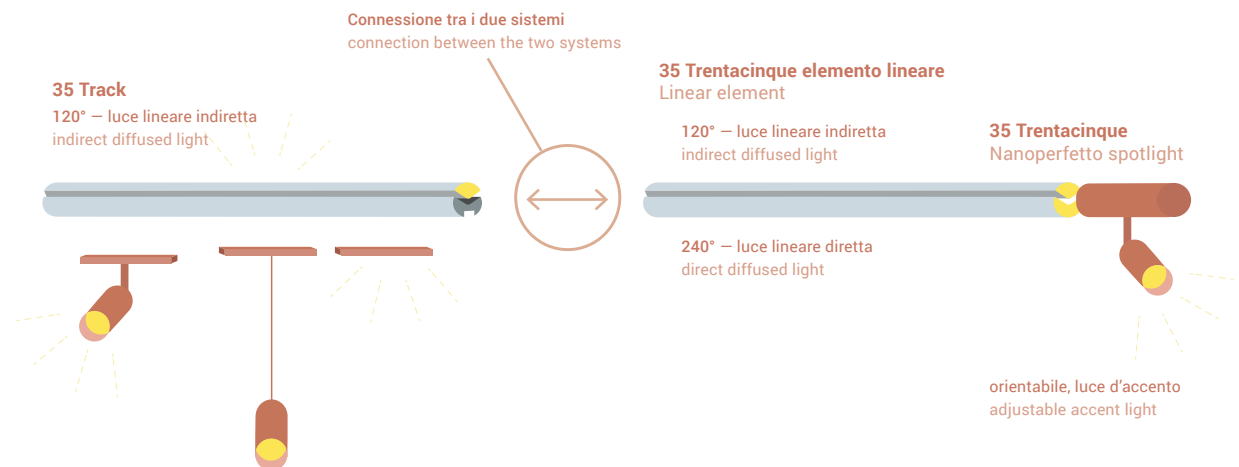



# 35 sistema lineare sospeso

## 35 suspended linear system

Elemento lineare in alluminio anodizzato con diffusori in policarbonato; giunti di connessione e proiettore in pressofusione di alluminio verniciato poliester.

Linear element in anodized aluminium with diffusers in polycarbonate; connection joints and projector in die-cast.

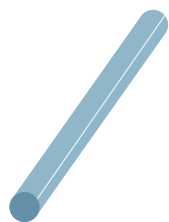

elemento lineare  
linear element  
(master + continuous)



Nanoperfetto 35  
proiettore  
spotlight



giunto L  
L joint



kit di sospensione  
suspension kit



giunto flessibile  
flexible joint

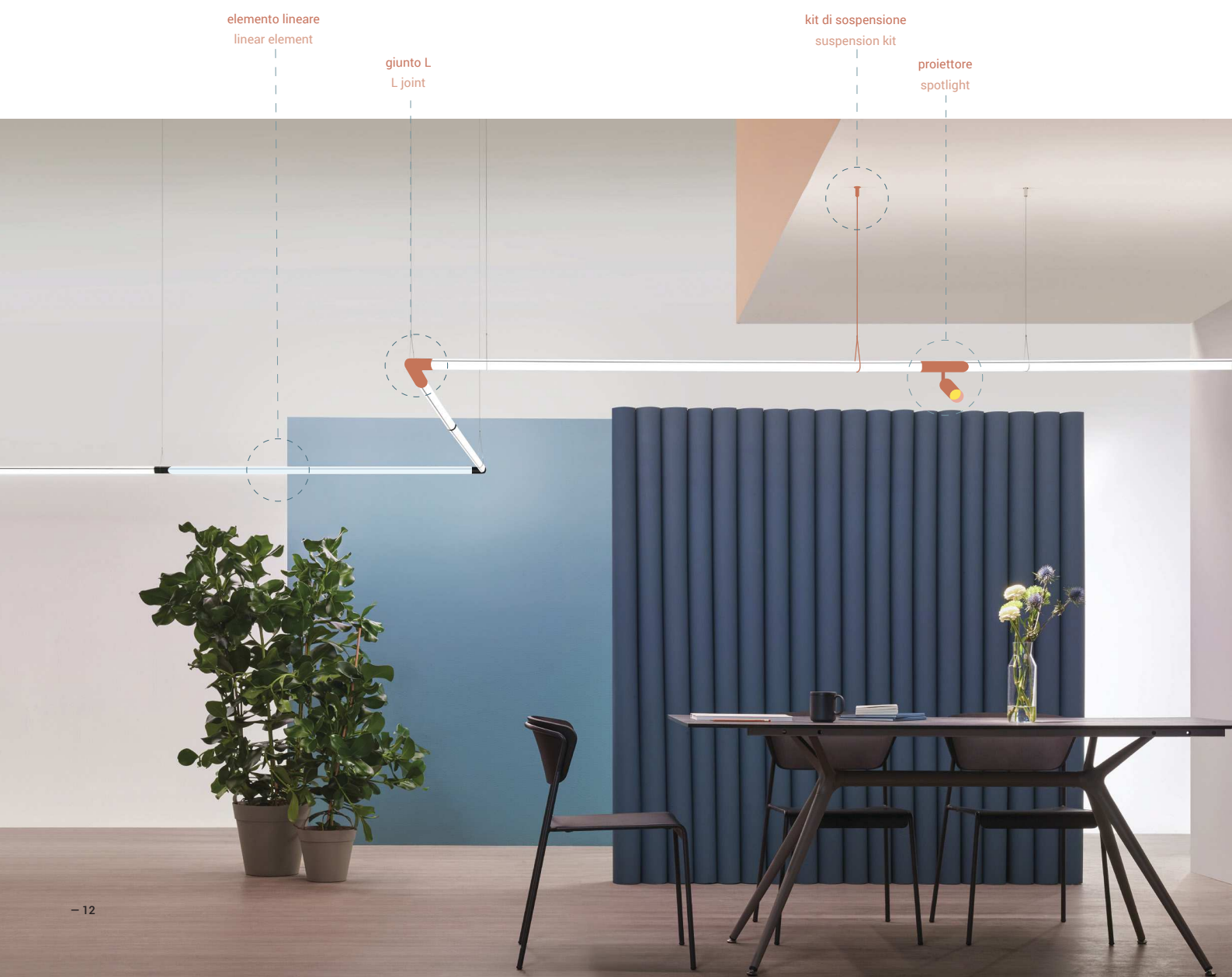

# 35 track + 120° uplight

35 track + 120° uplight

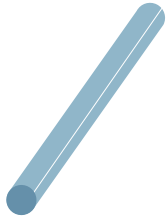

elemento lineare track  
track linear element



proiettori 48Vdc  
48Vdc spotlights



Minirooler  
linea di luce d'accento  
accent light line



sospensione 48Vdc  
48Vdc pendant



Linea 48  
linea di luce diffusa  
diffused light line

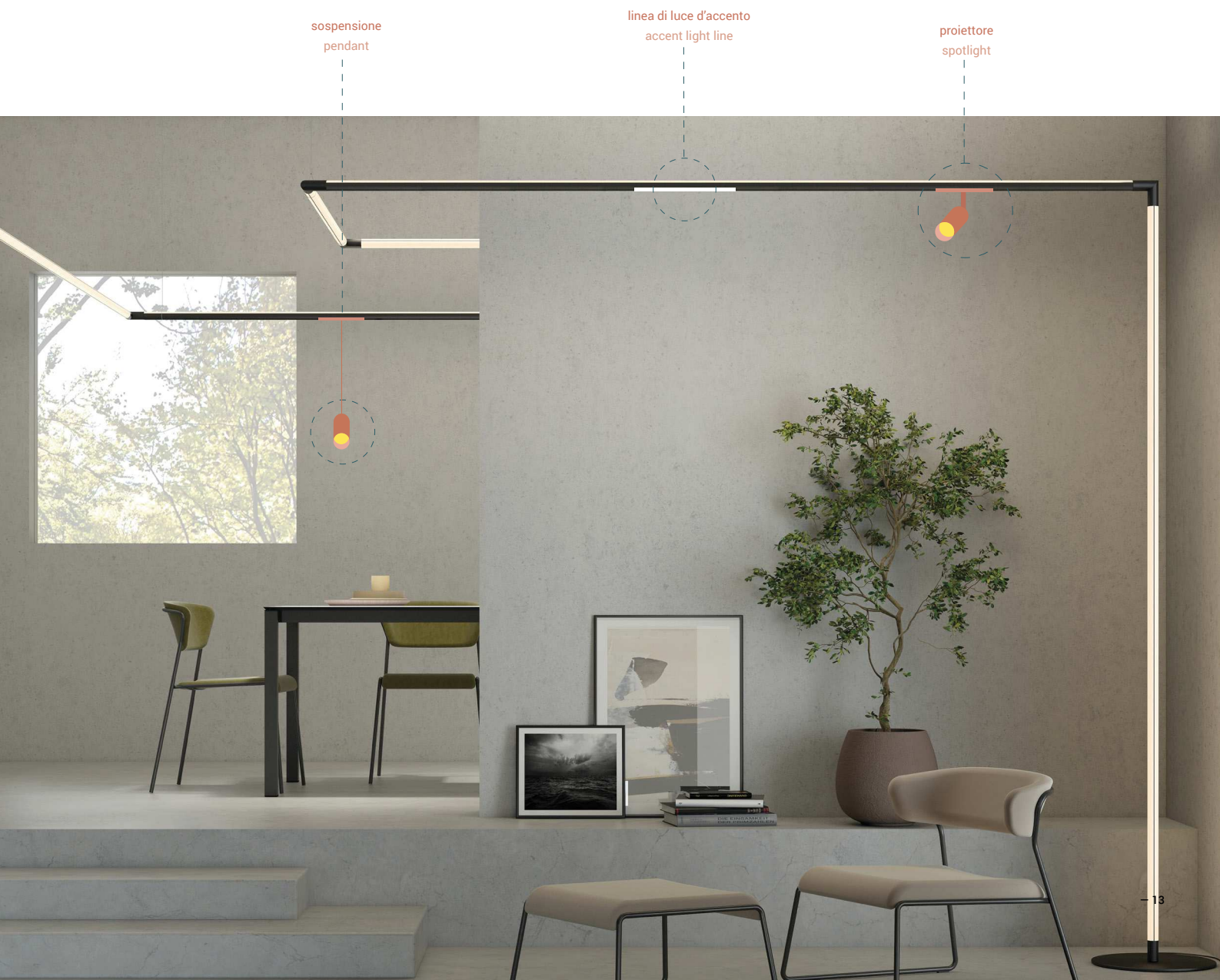

sospensione  
pendant

linea di luce d'accento  
accent light line

proiettore  
spotlight

# Applicazioni

## Applications

### 01. **architetturale** architectural

35 e 35 Track garantiscono una confortevole illuminazione architettonica, combinando luce diffusa diretta, indiretta e d'accento, lasciando libertà di scelta di accensioni e di dimmerazione.

35 and 35 Track combine diffused direct and indirect as well as accent light, giving designers the freedom to create diverse architectural lighting installations from one product.

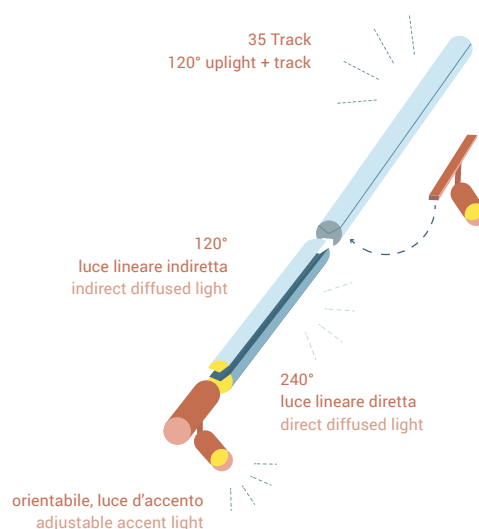

### 02. **dettagli/nicchia** details/cove

Trentacinque (35) svolge particolari prestazioni illuminotecniche di cove-lighting, nelle nicchie e nei controsoffitti: grazie all'emissione di luce a 360°, l'illuminamento nelle nicchie risulta morbido e omogeneo, senza ombre.

Trentacinque (35) can also be used in cove-lighting, niches and ceiling details: thanks to the 360° light emission, the distribution is soft and homogeneous, without shadows.

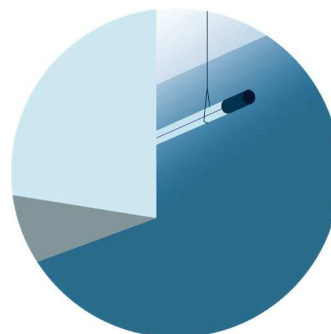

### 03. **scultura grafica** graphical statement

Trentacinque (35) nasce dinamico, concepito per il controllo del singolo pixel fin dalla sua ideazione. Può quindi essere controllato in RGBW, in DMX o in SPI, nella sua lunghezza e a 360° (versioni su richiesta, per minimi d'ordine). Questo lascia ai designer la libertà di specificare una versione totalmente dinamica, oppure di aggiungere questa funzionalità tra le altre applicazioni architettoniche del prodotto.

Trentacinque (35) is born dynamic; it was envisaged as pixel controlled from its creation, therefore, it can be supplied in RGBW, DMX or SPI controllable linear lengths with individual pixel control lengthways and in 360° (versions on demand, for minimum order quantities). This allow designers the freedom to specify a fully dynamic version or use this dynamic feature as part of the architectural version of the product.

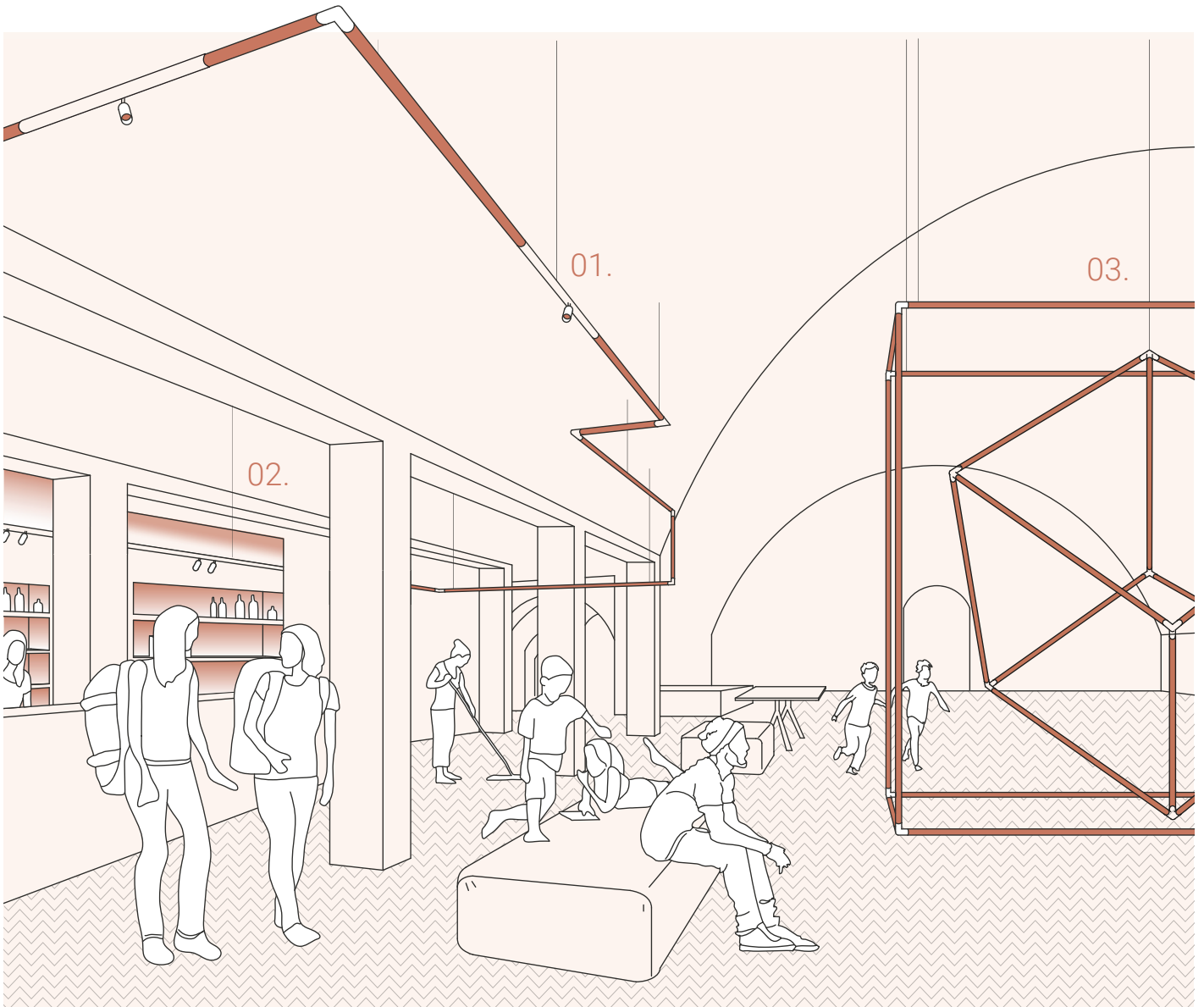

Trentacinque (35) può avere, su richiesta per minimi d'ordine, opzioni Dim to Warm, Tunable white, RGB, RGBW e Single Pixel. Gli elementi in alluminio hanno colore standard bianco, nero e oro satinato.

35 Track può essere equipaggiato con proiettori 48Vdc, minirooler, linea 48 e sospensioni 48Vdc.

Trentacinque (35) can perform, on demand for minimum orders, Dim to Warm, Tunable white, RGB, RGBW and Single Pixel options. Aluminium elements are black, white and satin gold.

35 Track can be equipped with all 48VDC track fixtures (spotlights, minirooler, linea 48 and pendants).

# Configurazione

## Configuration

Tutti gli elementi lineari permettono la continuità elettrica all'elemento successivo con un giunto lineare integrato.

Every linear element powers the next element through an integrated connection.



Schemi di dimmerazione scaricabili dal sito

Dimming schemes can be downloaded from the web site

# Diffusori

## Diffusers

Il sistema lineare sospeso 35 è disponibile con due varianti di diffusore.

E' possibile optare per il diffusore opale che sembra bianco quando è spento. Oppure si può scegliere il diffusore fumé grigio molto scuro quando spento, ma diventa bianco e luminoso quando acceso. Quest'ultimo è particolarmente accattivante se abbinato alla finitura nera oppure oro satinato.

The 35 suspended linear system comes with two option of diffuser.

You can either go for the opal diffuser which looks white when switched off.  
Or you can choose the smokey diffuser which goes very dark grey when switched off, but still white and bright when switched on.  
This is particularly good looking with the black or gold finish.



Diffusore fumé spento  
Smokey diffuser switched off

Diffusore fumé acceso  
Smokey diffuser switched on

# Finiture

## Finishes

Il sistema 35 è disponibile nelle finiture bianco, nero o oro satinato. Il sistema 35 Track + 120° è disponibile in bianco o nero.

The 35 system comes as white, black or satin gold as standard finished. The 35 Track + 120° system comes in black or white.



# Scene

## Scenes

### 01. **designing**

Il sistema Trentacinque (35) permette una configurazione libera di elementi, combinando luce diffusa e luce d'accento.

Trentacinque (35) system allows a free configuration of elements, combining diffused and accent lighting.

### 02. **grouping**

In fase di installazione, è possibile raggruppare tutti gli elementi luminosi del Trentacinque (35) in diversi gruppi o scene.

The Trentacinque (35) can be wired into separate groups, allowing independent control of the down, up and spot light components.

### 03. **enlighting**

Si possono in questo modo accendere indipendentemente i gruppi configurati, a seconda delle esigenze di design.

The different groups can be independently switched on, following the different design needs.



Esempio di raggruppamento:  
tre diverse scene di luce, con  
un unico cavo di alimentazione.

Example of grouping: three different  
scenes of light, with a single supply  
cable.

#### UPLIGHT + DOWNLIGHT

Luce soffusa e non abbagliante per segni  
lineari a 360°.

Soffused and not glary lighting for 360°  
linear application.

---



#### UPLIGHT + SPOTLIGHT

Grazie alla doppia accensione 120° + 240°,  
35 permette una distribuzione morbida  
indiretta anche in caso di distanza ridotta  
del soffitto/parete.

Thanks to the double switch 120° + 240°,  
35 allows a soft indirect distribution even in  
case of low distance from the ceiling / wall.

---

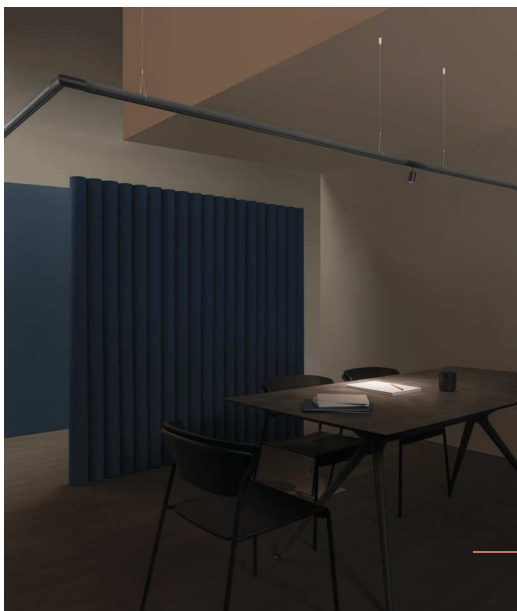

#### SPOTLIGHT

Luce d'accento per focalizzare  
l'attenzione su oggetti e dettagli, con  
UGR<15 e distribuzioni luminose  
simmetriche / asimmetriche.

Accent light for focusing on  
objects and details, with UGR<15  
and symmetric / asymmetric light  
distribution.

---

## 35 Trentacinque

linear system – interior –

ELEMENTO LINEARE MASTER / MASTER LINEAR ELEMENT

ELEMENTO LINEARE CONTINUO / CONTINUOUS LINEAR ELEMENT

Trasformatori da ordinare separatamente  
Transformers should be ordered separately

<b>81-09000</b>	100 W	48V <sub>DC</sub> Trasformatore PWM per uso remoto PWM transformer for remote use
<b>81-09001</b>	200 W	48V <sub>DC</sub> Trasformatore PWM per uso remoto PWM transformer for remote use

Dimmer da ordinare separatamente  
Dimmers should be ordered separately

<b>81-90089</b>	Dimmer Casambi Bluetooth 4 canali / 4 channels
<b>81-90123</b>	Dimmer PWM

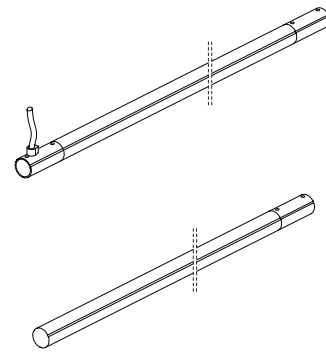

## 35 Trentacinque

NANOPERFETTO CONTINUO / CONTINUOUS NANOPERFETTO

Trasformatori da ordinare separatamente  
Transformers should be ordered separately

<b>81-09000</b>	100 W	Trasformatore PWM per uso remoto PWM transformer for remote use
<b>81-09001</b>	200 W	Trasformatore PWM per uso remoto PWM transformer for remote use



## 35 TRACK

Trasformatori da ordinare separatamente  
Transformers should be ordered separately

<b>81-09000</b>	100 W	Trasformatore PWM per uso remoto PWM transformer for remote use
<b>81-09001</b>	200 W	Trasformatore PWM per uso remoto PWM transformer for remote use
<b>81-90122</b>	300 W	Trasformatore PWM per uso remoto PWM transformer for remote use
<b>6465-03-31</b>	150 W	Trasformatore DALI per uso remoto DALI transformer for remote use
<b>6468-03-31</b>	120 W	Trasformatore per uso remoto Transformer for remote use

Dimmer e controller da ordinare separatamente  
Dimmers and controller should be ordered separately

<b>81-90089</b>	Dimmer Casambi Bluetooth 4 canali / 4 channels
<b>81-90123</b>	Dimmer PWM
<b>81-90124</b>	Dimmer DALI
<b>81-90128</b>	Controller DALI Bluetooth



Schemi di dimmerazione  
scaricabili dal sito

Dimming schemes can  
be downloaded from the  
web site







Kit montaggio parete / soffitto  
Kit for wall / ceiling mounting



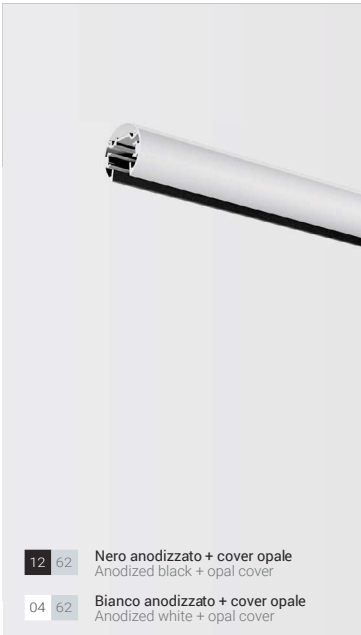

- 12 62 Nero anodizzato + cover opale  
Anodized black + opal cover
- 04 62 Bianco anodizzato + cover opale  
Anodized white + opal cover

Codice	Lunghezza
Code	Length (mm)

**Binario sospeso a bassa tensione 48V con diffusore opalino per uplight 120°.**  
Suspended 48V low voltage track, with opal diffuser for 120° uplight.

6447-15	1500
6447-20	2000
6447-30	3000

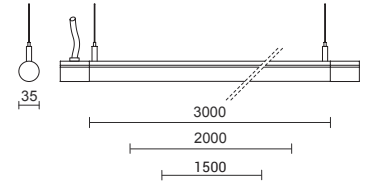

48Vdc



Equipaggiabile con proiettori 48Vdc, vedi pag. 86.  
It can be equipped with 48Vdc track lights, see page 86.



**6490-10**  
Alimentazione destra  
Right live-end  
30 Nero / Black  
31 Bianco  
White



**6490-11**  
Alimentazione sinistra  
Left live-end  
30 Nero / Black  
31 Bianco  
White



**6491-00**  
Alimentazione centrale  
Central connector  
30 Nero / Black  
31 Bianco  
White



**6492-00**  
Giunto Lineare Elettrico  
Straight electric connector  
30 Nero / Black  
31 Bianco  
White



**6493-10**  
Giunto lineare meccanico  
Linear mechanical joint  
30 Nero / Black  
31 Bianco  
White



**6494-10**  
Giunto a L interno  
Inside L joint  
30 Nero / Black  
31 Bianco  
White



**6494-11**  
Giunto L esterno  
Outside L joint  
30 Nero / Black  
31 Bianco  
White

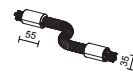

**6495-00**  
Giunto flessibile  
Flexible joint  
30 Nero / Black  
31 Bianco  
White

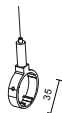

**6496-00**  
Kit di sospensione con anello,  
cavo 3mt e bloccacavo  
Suspension kit with ring,  
wire 3mt and wire lock  
16 Nero / Black  
21 Bianco mat  
Mat white



**6497-00**  
Kit di sospensione con anello  
rigido e tige rigida 1m  
Suspension Kit with stiff  
ring and stiff rod 1mt  
16 Nero / Black  
21 Bianco mat  
Mat white



**6498-00**  
Copertura Binario 1000mm  
Track cover 1000mm  
30 Nero / Black  
31 Bianco  
White



**6499-00**  
Chiusura  
Dead end  
30 Nero / Black  
31 Bianco  
White



**6500-00**  
Giunto meccanico di collegament  
35/35 Track  
Mechanic connection  
joint 35/35 Track  
16 Nero / Black  
21 Bianco mat  
Mat white



**6501-00**  
Giunto meccanico di collegam  
ent a L 35/35 Track  
Mechanic connection  
L joint 35/35 Track  
16 Nero / Black  
21 Bianco mat  
Mat white



**93-WB948-2520A-30** (3000mm)  
Kit Striplad cablata 48V  
Wired stripled kit 48V  
24W/m 2585lm/m 3000K



**93-WC948-2450A-30** (3000mm)  
Kit Striplad cablata 48V  
Wired stripled kit 48V  
24W/m 2450lm/m 2700K

Accessori ottici intercambiabili  
Replaceable optical accessories



**46-08** (1500mm)  
Diffusore fumé  
Smoked diffuser



**46-17** (2000mm)  
Diffusore fumé  
Smoked diffuser



**46-09** (3000mm)  
Diffusore fumé  
Smoked diffuser

## 35 Trentacinque

linear system – interior –

ELEMENTO LINEARE MASTER / MASTER LINEAR ELEMENT

ELEMENTO LINEARE CONTINUO / CONTINUOUS LINEAR ELEMENT

Trasformatori da ordinare separatamente  
Transformers should be ordered separately

81-09000	100 W	48V <sub>DC</sub> Trasformatore PWM per uso remoto PWM transformer for remote use
81-09001	200 W	48V <sub>DC</sub> Trasformatore PWM per uso remoto PWM transformer for remote use

Dimmer da ordinare separatamente  
Dimmers should be ordered separately

81-90089	Dimmer Casambi Bluetooth 4 canali / 4 channels
81-90123	Dimmer PWM

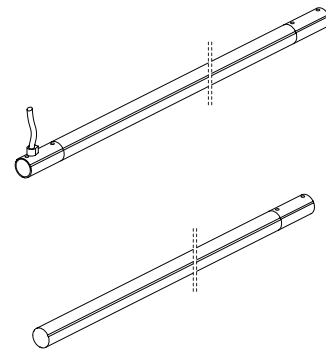

## 35 Trentacinque

NANOPERFETTO CONTINUO / CONTINUOUS NANOPERFETTO

Trasformatori da ordinare separatamente  
Transformers should be ordered separately

81-09000	100 W	Trasformatore PWM per uso remoto PWM transformer for remote use
81-09001	200 W	Trasformatore PWM per uso remoto PWM transformer for remote use



## 35 TRACK

Trasformatori da ordinare separatamente  
Transformers should be ordered separately

81-09000	100 W	Trasformatore PWM per uso remoto PWM transformer for remote use
81-09001	200 W	Trasformatore PWM per uso remoto PWM transformer for remote use
81-90122	300 W	Trasformatore PWM per uso remoto PWM transformer for remote use
6465-03-31	150 W	Trasformatore DALI per uso remoto DALI transformer for remote use
6468-03-31	120 W	Trasformatore per uso remoto Transformer for remote use

Dimmer e controller da ordinare separatamente  
Dimmers and controller should be ordered separately

81-90089	Dimmer Casambi Bluetooth 4 canali / 4 channels
81-90123	Dimmer PWM
81-90124	Dimmer DALI
81-90128	Controller DALI Bluetooth



Schemi di dimmerazione  
scaricabili dal sito

Dimming schemes can  
be downloaded from the  
web site

